

**KNOCKOUT TABLE:**

H= 9/32" KO
G= 1/2", 3/4", 1" KO
B= 1", 1-1/4", 1-1/2" KO
D= 3/4", 1", 1-1/4" KO

**WIRE RANGE TABLE :**

CONNECTOR	COPPER		ALUMINUM	
	SOLID	STRAND	SOLID	STRAND
LINE	---	6-1/0	---	6-1/0
LOAD	14-10	14-10	---	---
NEUTRAL LARGE HOLE	12-8	12-1/0	10	10-1/0
NEUTRAL SMALL HOLE	14-8	14-4	12-10	12-4
EQUIP. GRND.	12-2	12-2	12-2	12-2

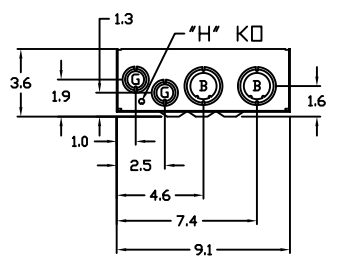
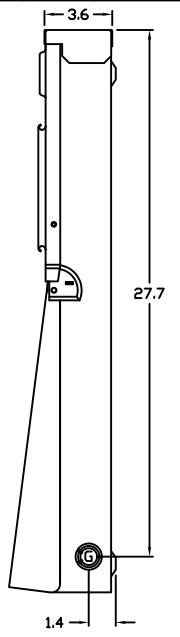
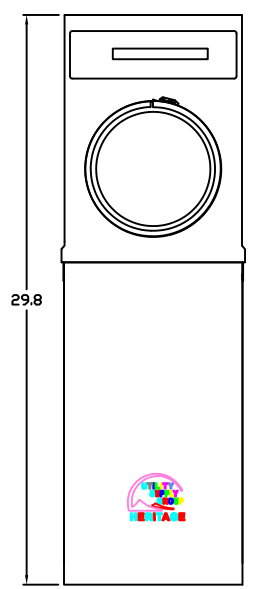
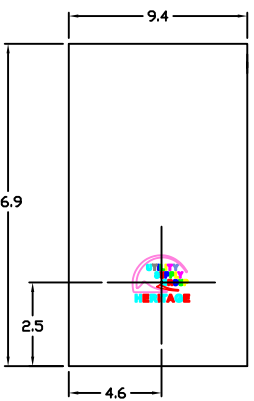
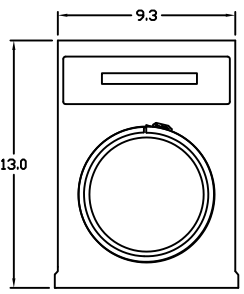
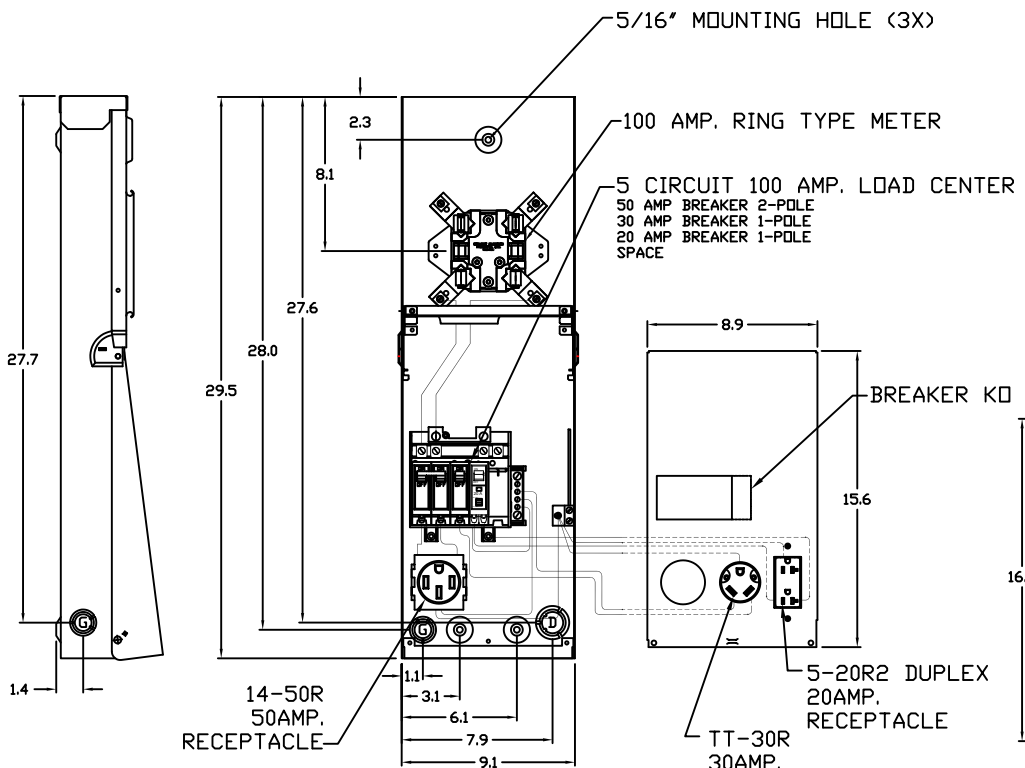

SH190

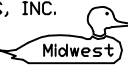
MIDWEST ELECTRIC PRODUCTS, INC. Plainville, CT 	* = Critical To Quality Unless Otherwise Specified Tolerances On: 3 Pl. Decimals ± .010 2 Pl. Decimals ± .030 Fractions ± 1/32 Angles ± 1/2° Holes ± .003 Dimensions Are In Inches	AutoCad Generated		TITLE: MH75GSM3 OUTLINE DRAWING DWG NO: 198B8604
		SCALE: 1 : 1	SIZE: A	
Dr. By: PURNA Dt: 06/17/16 Ck. By: SURESH CN: C014304 Dt: 06/17/16				

Rev.1 C014304 PURNA 06/17/16